

# Electromagnetic Lock

## User Manual

Read the manual before usage and keep for future reference.

CE FC RoHS

### 1. Application Range

1. Door Types: Wooden door, Glass door, Metal door, Fireproof door.
2. Control Mode: Building intercom system, Access control system.

### 2. Note

1. Using powerful power supply, output voltage should be  $DC12V \pm 10\%$ , cable  $> 0.75mm$ .
2. Don't hurt the galvanization layer during the installation.
3. Ensure the mounting plate well attach to the lock body.
4. The rubber ring must be added between armature plate and door leaf, don't fasten the screw tightly, keep the rubber ring elastic.
5. Don't welded the mounting plate to the door, or will effect the lock.
6. Clean the slushing oil with cloth, don't use alkaline or pungent cleaner.

### 3. Wiring of Lock

#### 1. 12V-DC input:

Positive pole of 12V-DC connect to the terminal marked with "+"  
Negative pole of 12V-DC connect to the terminal marked with "-"  
Ensure the Voltage Selector is switched to 12V-DC.

#### 2. 24V-DC input:

Positive pole of 24V-DC connect to the terminal marked with "+"  
Negative pole of 24V-DC connect to the terminal marked with "-"  
Ensure the Voltage Selector is switched to 24V-DC.

#### 3. Wiring of Door-State Detector

The overload current of relay contact is 1amp. when the input is 24V-DC, overload is strictly prohibited. Connect the normal-open circuit to the COM and NC for getting switch-over signal. But connect the normal-close circuit to the COM and NO for getting switch-over signal.

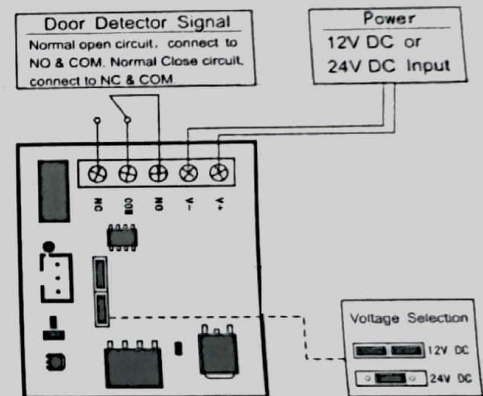

Connection Diagram

**Note:** Please use the 12V-DC input if the lock has not special annotate.  
The overload voltage will damage the lock.

### 4. Main Components Diagram

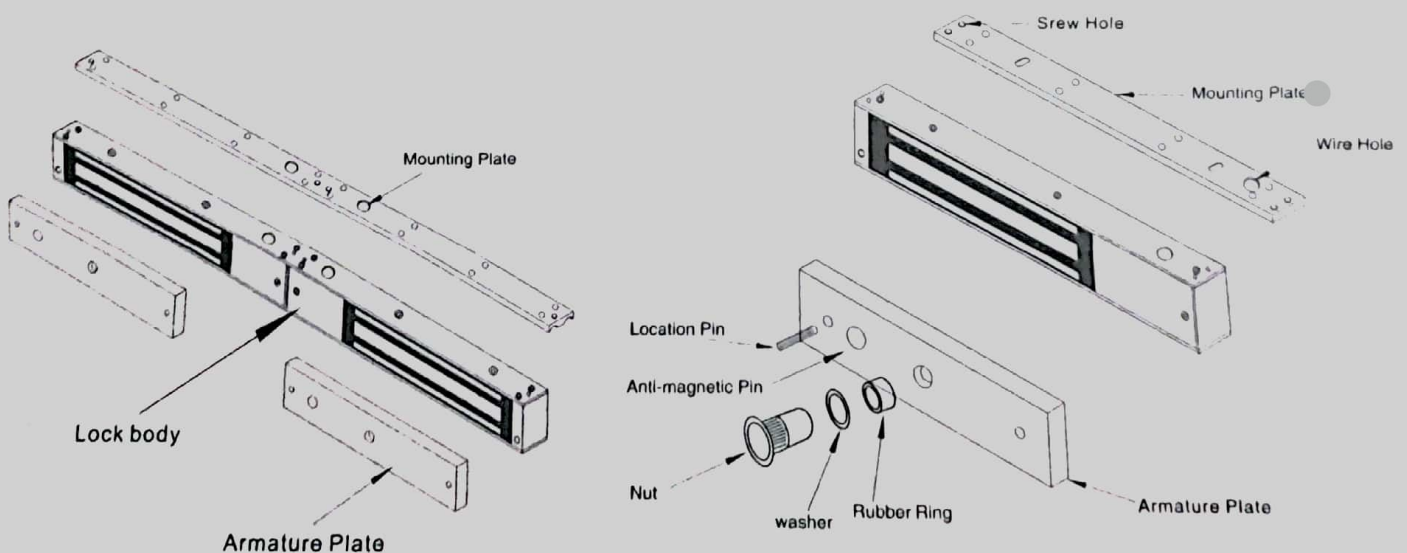

## 5. Disassemble Procedure

Disassemble the cover and band before installing the lock.

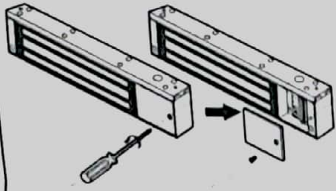

1. Unfasten the screw and open the cover.

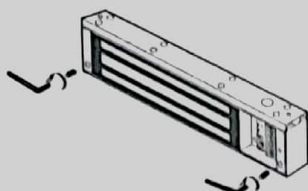

2. Unscrew the anti-disassemble bolts with hex key.

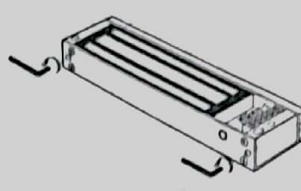

3. Use Allen Key to loose the screw of the Mounting plate.

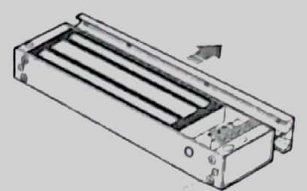

4. Unfold the Mounting plate from the lock body.

## 6. Standard Mounting Method

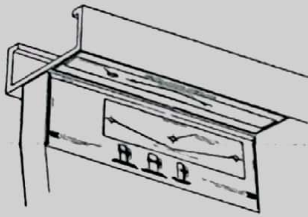

1

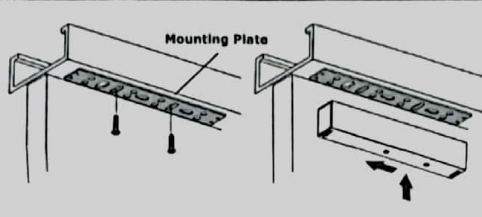

2

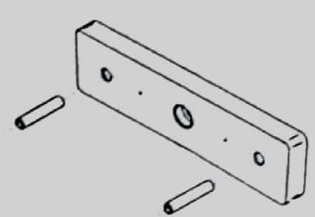

3

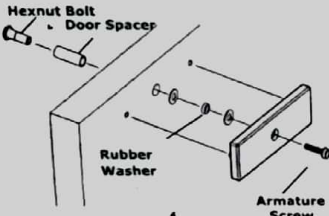

4

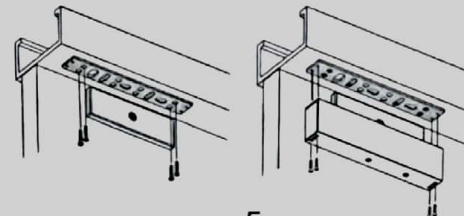

5

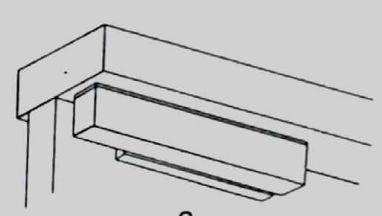

6

1. Use the supplied template to determine the correct location and size of mounting holes for both the door and frame header. Ensure that the door opens away from the Maglock. In the case of a single door, the Maglock is positioned as close as possible to the vertical section of the door jamb. Drill door and frame as indicated.
2. Loosely install the mounting plate using two of the supplied Philips head mounting screws in the elongated slots. Attach the Maglock to the mounting plate.
3. Using a hammer, lightly tap both roll pins into the armature plate until they are secure.
4. Before installing the Hexnut, the hole in the door may need to be drilled or tapped. Refer to page 2 for this information. Using the components shown in the image to the right, mount the armature to the door. Make sure that the armature plate is not over tightened and that it is installed as shown in the following diagram. The armature plate must be free to self align with the door.
5. Ensure the armature and magnet are aligned. Adjust the mounting plate to suit and then drill the appropriate sized holes in the door header for the remaining attachment screws.
6. Close the door to test holding force. The angle between armature plate and magnetic lock can be adjusted by adding or reducing washers.

## 7. Bracket Mounting Method

When the door width is less than 42mm the width is not enough for Armature Plate of the magnetic lock installed, it need to add the additional L type bracket.

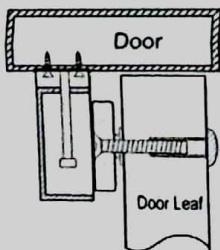

L Mounting Bracket

For in-swing door, install the lock body inside and then need to install the ZL bracket at the same time.

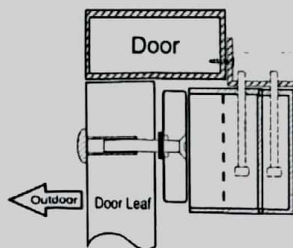

ZL Mounting Bracket

Magnetic locks installed in glass doors require extra U bracket (for 10-15mm glass door thick).

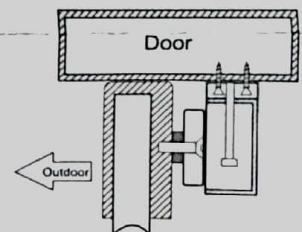

U Mounting Bracket