

5380035E

CONJUNTOS ARMADOS LÍNEA DOMICILIARIA CAFÉ/TITANIO ARMADO

Los conjuntos armados son con placa de tecnopolímero, en terminación metalizada mate para los conjuntos color café/titanio.

La Línea Domiciliaria de Lexo Electric certificada, bajo las Normas IEC 60884-1:2006 y CEI 23-50:2007-03, entre otras.

Para los comandos: IEC 60669-1:2007 y NCh2011Of.2009, entre otras.



5380034E



5380036E

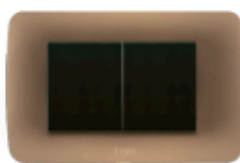

5380035E



5380048E



5380125E



5380128E



5380131E



5380132E



5380133E



5380126E



5380130E



5380124E



5380129E



5380127E



5380123E



58401003













58402003

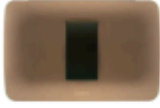











5380912E

DATOS TÉCNICOS

Producto	Código	Descripción	Modelo	Tensión	Corriente	Estándar
	5380034E	Interruptor simple 9/12 teclón 73mm 10A 250V café/titanio armado	KER-912	250V~50Hz	10A	IEC 60669 - 60884-1:2013, IEC 0884-2-7:2013, IEC 60884-3-1:2021
	5380036E	Interruptor conmutador 9/24 teclón 73mm 10A 250V café/titanio armado	KER-924	250V~50Hz	10A	
	5380035E	Interruptor doble 9/15 teclón 35,6mm 10A 250V café/titanio armado	KER-912	250V~50Hz	10A	
	5380037E	Interruptor pulsador timbre teclón 73mm 10A 250V café/titanio armado	KER-MT	250V~50Hz	10A	
	5380125E	Interruptor simple 9/12 10A 250V café/titanio armado	KER-912	250V~50Hz	10A	
	5380128E	Interruptor conmutador 9/24 10A 250V café/titanio armado	KER-924	250V~50Hz	10A	
	5380131E	Interruptor pulsador timbre 10A 250V café/titanio armado	KER-MT	250V~50Hz	10A	
	5380132E	Toma de corriente simple 10A 250V café/titanio armado	KER-10A	250V~50Hz	10A / 2+T	
	5380133E	Toma de corriente simple 10/16A 250V café/titanio armado	KER-10/16A	250V~50Hz	10-16A / 2+T	
	5380126E	Interruptor doble 9/15 10A 250V café/titanio armado	KER-912	250V~50Hz	10A	

DATOS TÉCNICOS

Producto	Código	Descripción	Modelo	Tensión	Corriente	Estándar
	5380130E	Interruptor simple 9/12 + toma corriente 10A 250V café/titanio armado	KER-912 KER-10A	250V~50Hz	10A / 2P+T	IEC 60669 - 60884-1:2013, IEC 0884-2-7:2013, IEC 60884-3-1:2021
	5380124E	Toma de corriente doble 10A 250V café/titanio armado	KER-10A	250V~50Hz	10A / 2P+T	
	5380129E	Toma de corriente doble 10A+10/16A 250V café/titanio armado	KER-10A KER-10/16A	250V~50Hz	10-16A 10A / 2P+T	
	5380127E	Interruptor triple 9/32 10A 250V café/titanio armado	KER-912	250V~50Hz	10A	
	5380123E	Toma corriente triple 10A 250V café/titanio armado	KER-10A	250V~50Hz	10A / 2P+T	
	58401003	Toma de corriente DÚPLEX 10A 250V café/titanio	MCK2	250V~50Hz	10A / 2P+T	
	58401007	Toma de corriente DÚPLEX 10/16A 250V titanio/café	MCK4	250V~50Hz	10/16A / 2P+T	
	58402003	Toma de corriente TRIPLEX 10A 250V café/titanio	MCK3	250V~50Hz	10A / 2P+T	
	58402007	Toma de corriente TRIPLEX 10/16A 250V titanio/café	MCK5	250V~50Hz	10/16A / 2P+T	
	5380912E	Placa ciega armada titanio	-	-	-	

DIMENSIONES (mm)

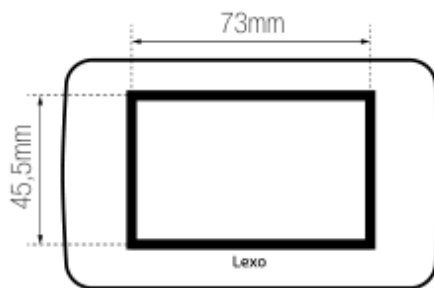
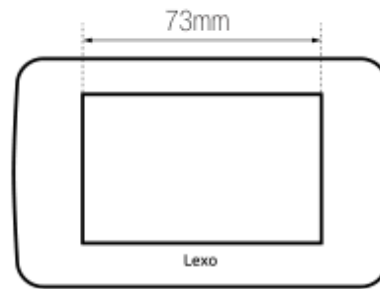
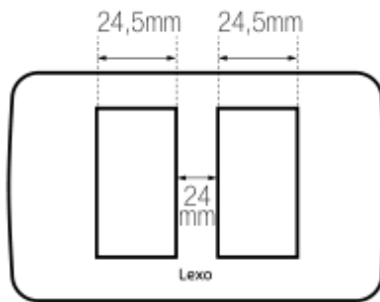
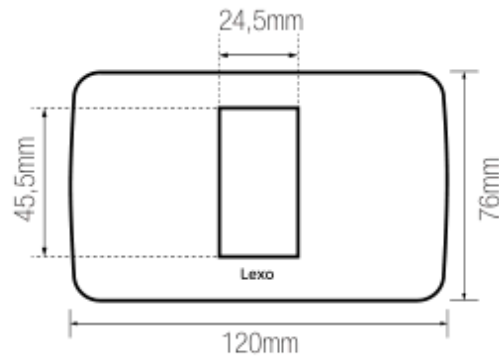

INTERRUPTOR TECLÓN 73mm

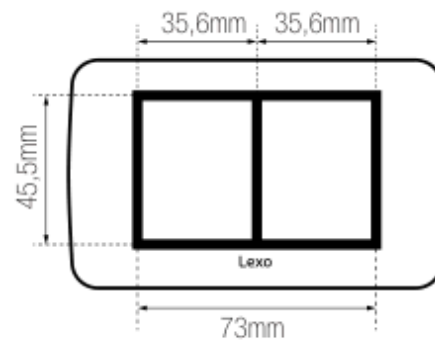

**INTERRUPTOR MEDIO
TECLÓN 35,6mm**